

# TX-W32/28D5F Operating Instruction

---

English

←  
BACK

EXIT

# Panasonic



## TX-W32D5F TX-W28D5F

Colour Television

**Quintrix**  
SUPER

**100Hz**  
SUPER DIGITAL SCAN

**WIDE  
DIGITAL  
P-L-U-S**

**Q-Link**

Operating  
Instructions

## WELCOME

Dear Panasonic Customer,

Welcome to the Panasonic family of customers. We hope that you have many years of enjoyment from your new colour television. This is a very advanced television; however, the Quick Start Guide will allow you to use the TV as quickly as possible. You can then read the instructions completely and retain them for future reference.

## CONTENTS

<b>Warnings and Precautions</b> .....	<b>2</b>	<b>Tuning Menu – Manual tuning</b> .....	<b>19</b>
<b>Accessories</b> .....	<b>3</b>	<b>OSD Language</b> .....	<b>20</b>
<b>Quick Start Guide</b> .....	<b>4</b>	<b>AV Select and Setup</b> .....	<b>21</b>
<b>Basic Controls</b> .....	<b>5</b>	<b>Q–Link</b> .....	<b>22</b>
<b>Using the On Screen Displays</b> .....	<b>6</b>	<b>VCR/DVD Operation</b> .....	<b>23</b>
<b>Aspect Controls</b> .....	<b>7</b>	<b>Teletext Operation</b> .....	<b>24</b>
<b>PIP Controls</b> .....	<b>9</b>	<b>Audio / Video Connections</b> .....	<b>26</b>
<b>STILL Control</b> .....	<b>9</b>	Via the front AV3 4 pin S–Video, RCA Audio / Video and Headphone Sockets .....	26
<b>Picture Menu</b> .....	<b>10</b>	Scart and S–Video Socket Information .....	26
<b>Sound Menu</b> .....	<b>11</b>	Via the rear AV1 / AV2(S) / AV4(S) 21 pin (Scart) and RCA Audio Out sockets .....	27
<b>Setup Menu</b> .....	<b>12</b>	<b>Trouble–shooting</b> .....	<b>28</b>
<b>Tuning Menu – overview</b> .....	<b>13</b>	<b>For your guidance</b> .....	<b>29</b>
<b>Tuning Menu – Programme edit</b> .....	<b>14</b>	<b>Specifications</b> .....	<b>29</b>
<b>Tuning Menu – Auto setup</b> .....	<b>18</b>		

## WARNINGS AND PRECAUTIONS

- This TV set is designed to operate on A.C. 220 – 240V, 50Hz.
- To prevent damage which might result in electric shock or fire, do not expose this TV set to rain or excessive moisture.
- **WARNING : HIGH VOLTAGE !!!**  
Do not remove the rear cover as live parts are accessible when it is removed. There are no user serviceable parts inside.
- Avoid exposing the TV set to direct sunlight and other sources of heat.
- The On/Off switch on this model does not fully disconnect the TV from the mains supply. Remove the mains plug from the wall socket when the TV set is not used for a prolonged period of time.
- **CABINET AND PICTURE TUBE CARE**  
Remove the mains plug from the wall socket. The cabinet and picture tube can be cleaned with a soft cloth moistened with mild detergent and water. Do not use solutions containing benzol or petroleum. TV sets can produce static electricity, care must be taken whenever touching the TV screen.
- Adequate ventilation is essential to prevent failure of electrical components, we recommend that a gap of at least 5cm is left all around this television receiver even when it is placed inside a cabinet or between shelves.

## ACCESSORIES

Check that you have the accessories and items shown 

Operating Instruction book  
TQB8E2608

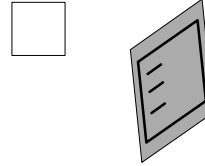
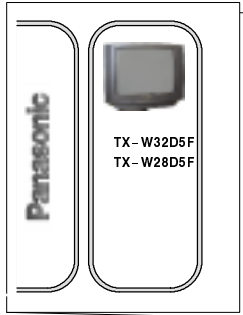

TV Guarantee



Remote Control Transmitter  
EUR511220



Batteries for the Remote Control  
Transmitter.  
(2 x R6 (UM3) size)



### Remote control batteries



- Make sure that the batteries are fitted the correct way round.
- Do not mix old batteries with new batteries. Remove old, exhausted batteries immediately.
- Do not mix different battery types, i.e. Alkaline and Manganese or use rechargeable (Ni-Cad) batteries.

# QUICK START GUIDE

## Quick Start Guide

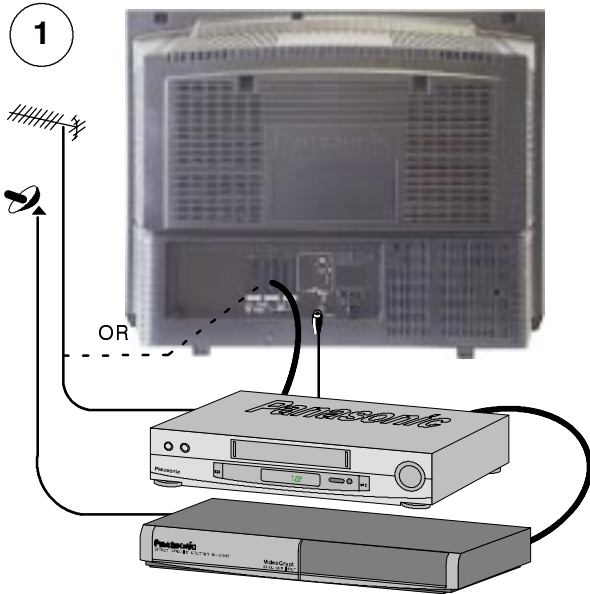

Plug in aerial and connect ancillary equipment

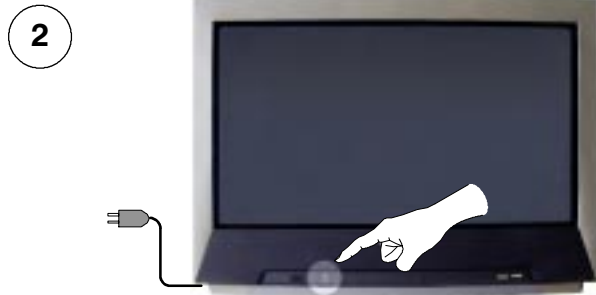

First, ensure that the **VCR is in Standby mode**

Plug in T.V. and switch on

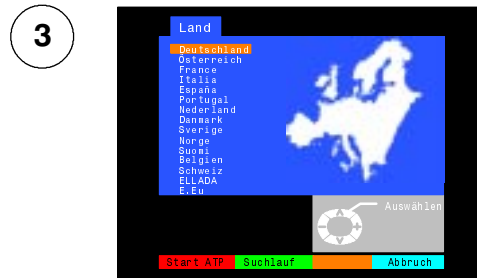

Select your country For Switzerland and Belgium, select the desired language



Press the red button

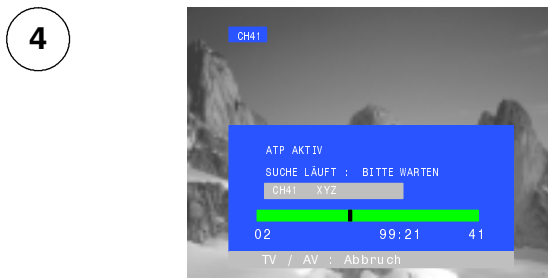

Auto setup will begin, your stations will be located and stored.

If a compatible VCR is connected to the AV2 socket, programme data will be downloaded to the VCR via Q-Link. See page 22.

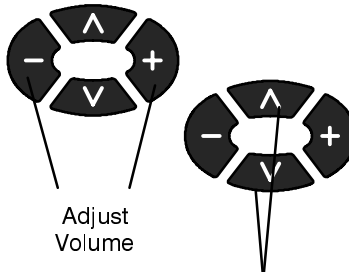
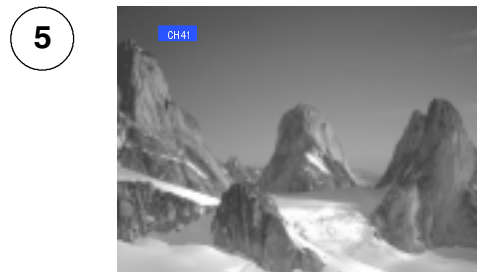

Adjust Volume

Change Channel

If you are installing a new Q-Link compatible VCR, you can now switch it ON. Downloaded tuning data will match the television's.

If you are installing a new NEXTVIEWLINK compatible VCR, you will need to initiate download manually. See the VCR handbook for details.

- If the VCR has not accepted download data from the TV, you may need to select the Download option from the VCR's menu.
- If Q-Link is not operating correctly, check it is connected to the television's AV2 socket, the SCART lead is a "full function" type, and the VCR is compatible with Q-Link, NEXTVIEWLINK or similar technologies. Ask your dealer for further details.
- For further information on Q-Link and connecting equipment, see pages 22, 26 and 27.

# BASIC CONTROLS : FRONT PANEL AND REMOTE CONTROL

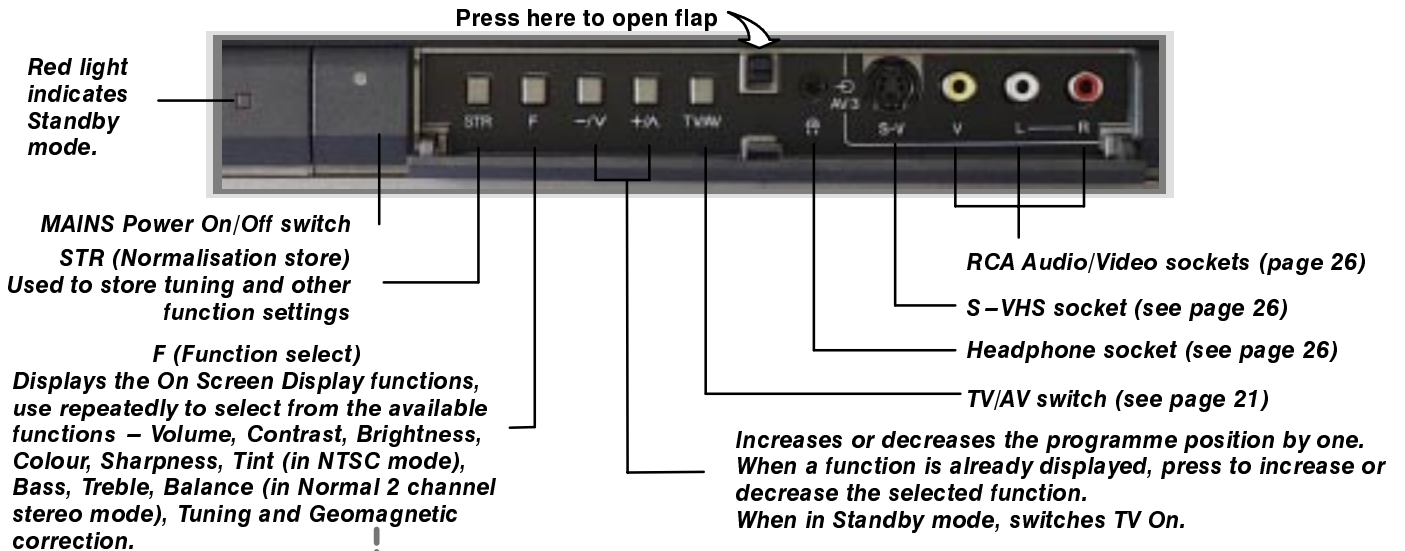

(TX-W32D5F only) Your geographical location may cause the picture to be slanted. Accessing the Geomagnetic Correction menu will allow you to correct the picture.

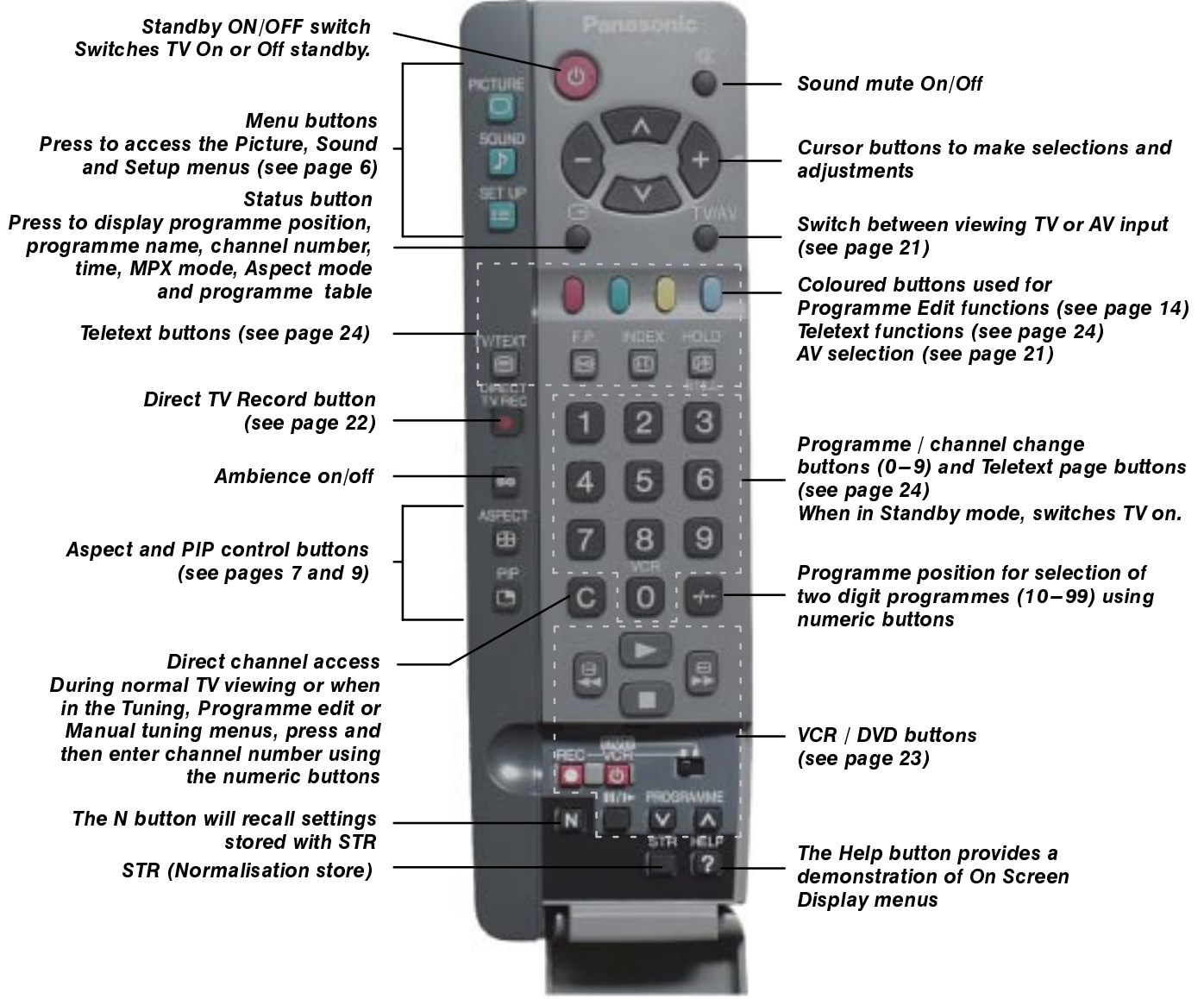

## USING THE ON SCREEN DISPLAYS

This TV has a comprehensive system of On Screen Display menus to access adjustments and options

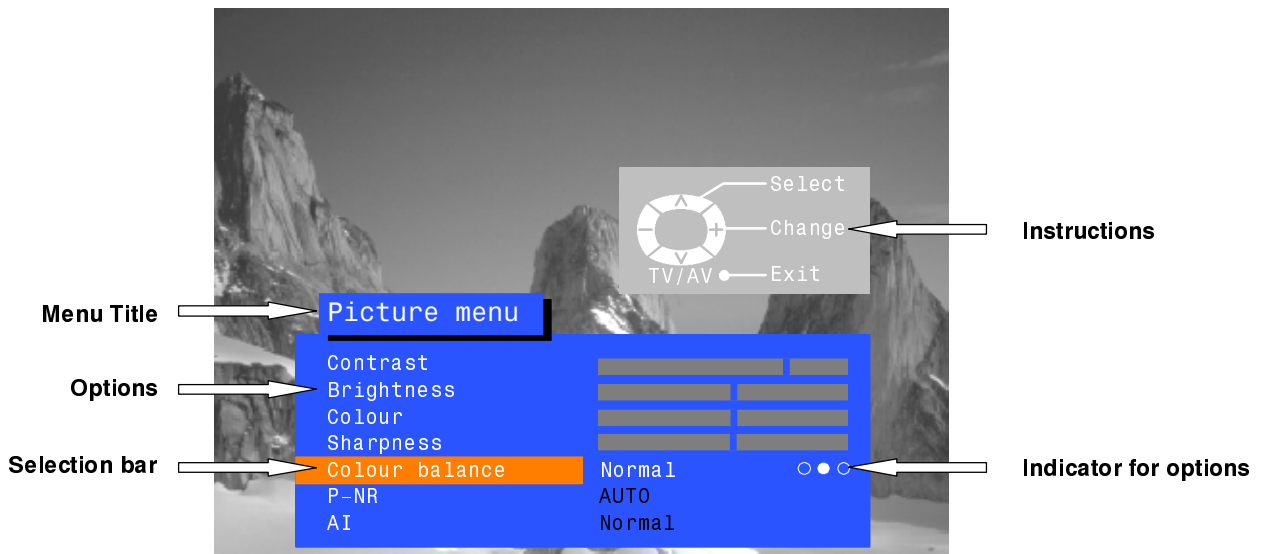

Some selections, for example, **Contrast**, **Brightness**, **Colour** and **Sharpness** will allow you to increase or decrease their level.

Some selections, for example, **Off timer**, allow a change of setting to be made.

Some selections, for example **Tuning menu**, will lead to a further menu.

The **PICTURE**, **SOUND** and **SET UP** buttons are used to open the main menus and also to return to the previous menu.



The up and down cursor buttons are used to move the cursor up and down the menu.



The left and right cursor buttons are used to access menus, adjust levels or to select from a range of options.

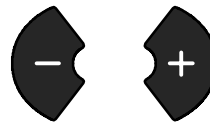

The **STR** button is used to store settings after adjustments have been made or options have been set.



The **TV/AV** button is used to exit the menu system and return to the normal viewing screen.



The **HELP** button will run a demonstration of the menus available. Press the **HELP** button and select one of the options.



If the **HELP** button is pressed whilst a menu is displayed, the 'Instructions' box will be hidden from view. Press the **HELP** button again to show the 'Instructions' box.



# ASPECT CONTROLS

The widescreen TV will allow you to enjoy viewing the picture at its maximum size, including widescreen 'cinema format' pictures.

Press the ASPECT button to move through the six aspect options: Panasonic Auto, 4:3, Zoom, S-Zoom, Full and Just

ASPECT



## Panasonic Auto

Some broadcasts are transmitted together with a wide screen identification signal (WSS). If the TV receives this signal then it will automatically switch to wide screen 16:9 mode, maximum display. The automatic widescreen switching depends upon reception conditions and the strength of the signal. If the signal is poor and therefore the WSS is weak then it is possible that the picture may not expand to full size and that the TV will display black areas around the edges.

If the original source signal was a standard 4:3 aspect ratio then you might prefer to view it in its original size; the red and green keys that appear will allow you to choose between viewing at standard 4:3 size or expanded in **Just** mode.

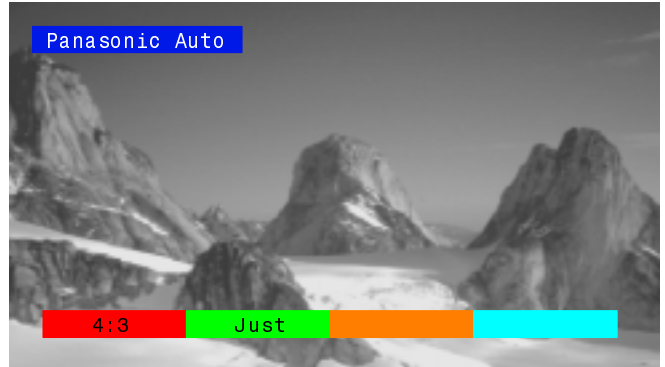

Panasonic Auto

## 4:3

4:3 will display a 4:3 picture at its standard 4:3 size and can be selected if you wish to view in this format.



4:3

## Zoom

**Zoom** mode magnifies the central section of the picture.

The picture can be moved and enlarged vertically using the coloured keys. The former adjustment is useful for viewing any sub-titles which may appear outside the picture.

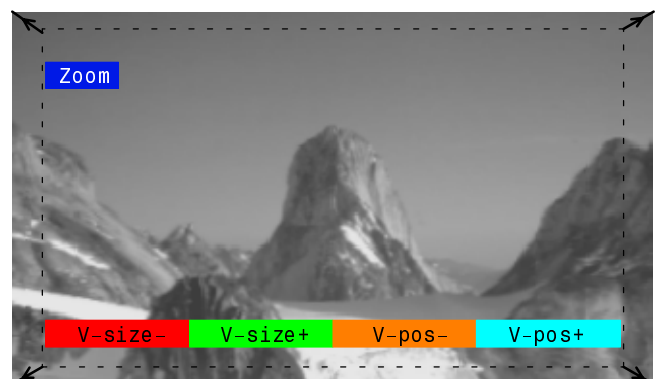

Zoom



# ASPECT CONTROLS

The on screen selector keys that appear for some aspect functions will clear after a few seconds. If you subsequently wish to select an operation then press the Aspect key once more for the keys to reappear.



The widescreen aspect ratios of different films and programmes can vary. If these are wider than a standard 16:9 aspect picture then a black band may be visible at the top and bottom of the screen.

If, in Panasonic Auto mode, you experience problems with the screen display size when playing back widescreen format recordings from your VCR then it is possible that the tracking control of your VCR requires adjustment (your VCR instruction book will contain adjustment details).

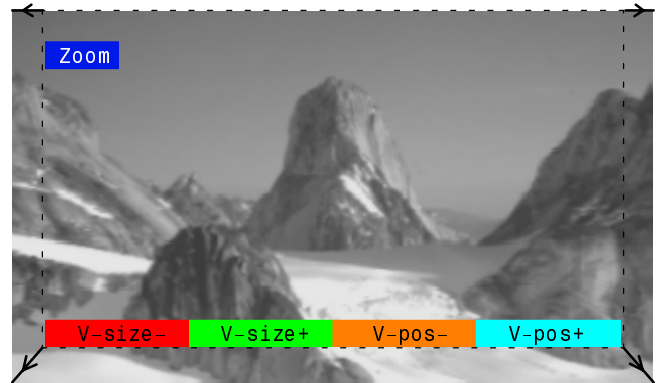

Blue key has been pressed to move picture upwards

## S-Zoom

**S-Zoom** allows increased magnification and the ability to move the picture horizontally and vertically.

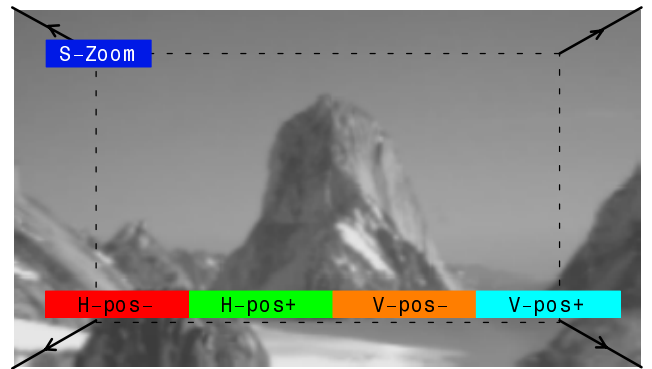

Increased magnification with **S-Zoom**

## Full

**Full** will display the picture at its maximum size but with slight elongation.



Full

## Just

**Just** mode will display a 4:3 picture at maximum size but with aspect correction applied to the centre of the screen so that elongation is only apparent at the left and right edges of the screen. The size of the picture will depend on the original signal.



Just

## PICTURE-IN-PICTURE (PIP) CONTROLS

PIP allows two pictures to be viewed at the same time.

The PIP key will switch the PIP function On and Off.



The red key (Locate) will allow you to select the position of the PIP picture.

The green key (Source) will allow you to select the current **TV** screen or the input to **AV1**, **AV2**, **AV3** or **AV4** as the PIP picture.

The yellow key (Swap) will allow you to swap the PIP picture with the main picture and vice-versa.

Pressing the PIP button a second time while the Locate, Source and Swap reminder is displayed will turn off PIP mode. The options available on the reminder bar depend upon the current aspect mode selected.



Pressing the PIP key will display the PIP picture

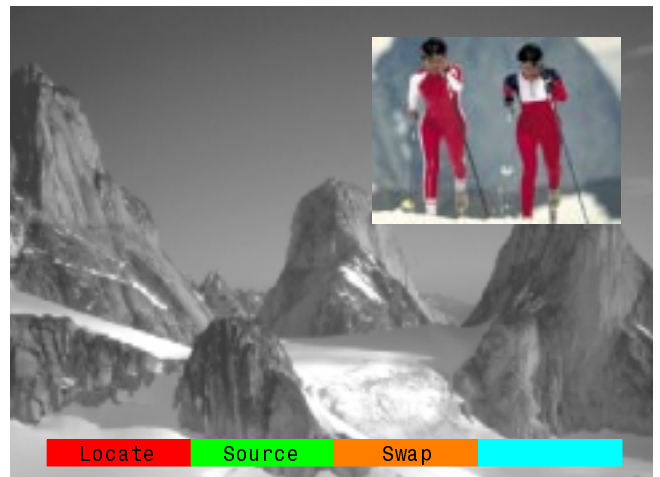

Above, the PIP picture has been moved to an alternative position by pressing the red key.

## STILL CONTROL

### STILL Control

The STILL key allows you to freeze the picture at any time.

When using the STILL key with the PIP function press to freeze the main picture, press again to release the main picture and freeze the PIP picture, press again to release the PIP picture.

HOLD  
  
STILL



# PICTURE MENU

Open the Picture menu

PICTURE



Move to your choice



Increase or decrease levels or set options



Press the TV/AV button to exit the Picture menu

TV/AV

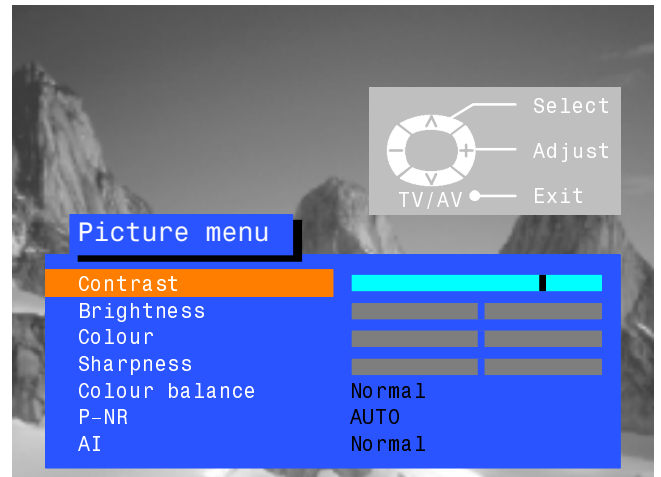

**Contrast**

**Brightness**

**Colour**

**Sharpness**

**Tint**

The Contrast, Brightness, Colour and Sharpness levels can be adjusted to suit your own preferences.

The Tint adjustment will only appear as a menu item if you have an NTSC signal source connected to the TV and will allow adjustment of the hue.

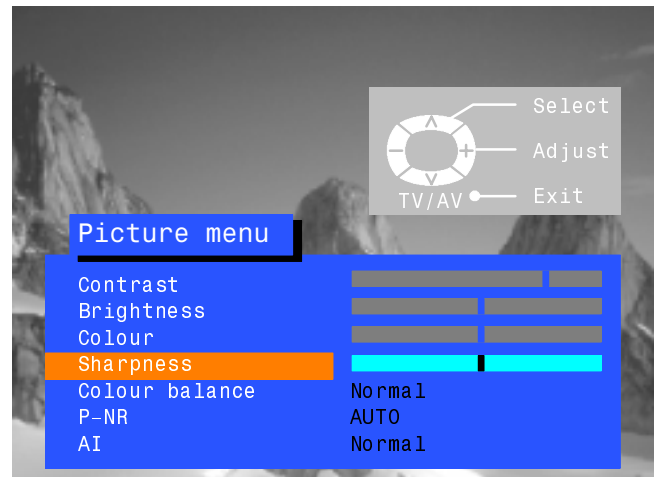

**Colour balance**



The Colour balance setting allows you to set the overall colour tone of the picture.

**P-NR**



P-NR will automatically reduce unwanted picture noise.

**AI**



AI automatically analyses the incoming picture and processes it to give improved contrast and optimum depth of field.



# SOUND MENU

Open the Sound menu



Move to your choice



Increase or decrease levels or set options



Press the TV/AV button to exit the Sound menu

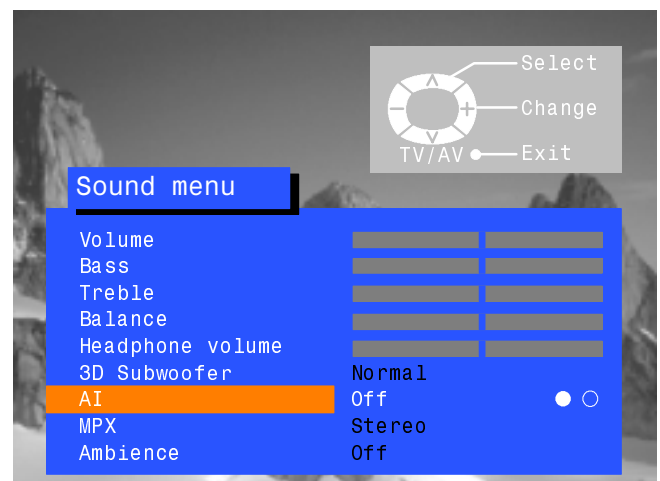
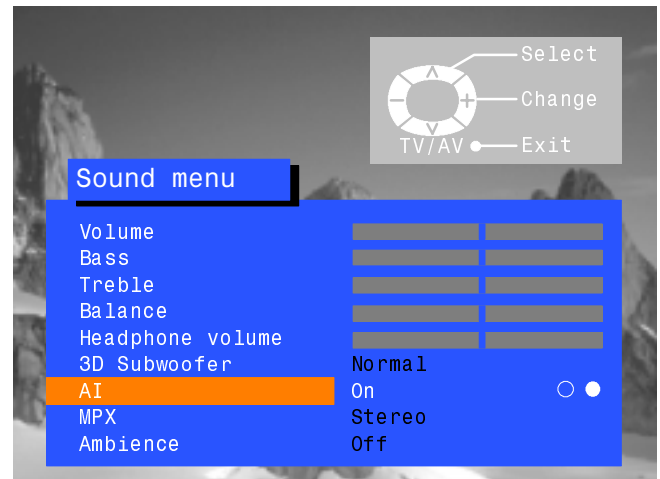
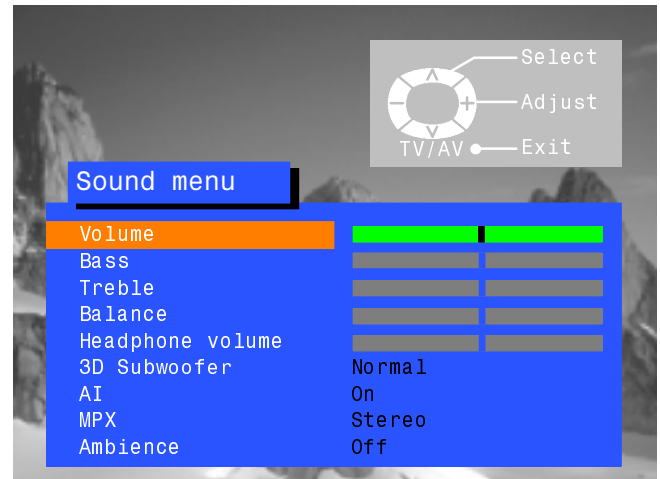

## Volume

The Volume adjustment sets the overall output volume.

## Bass

Bass adjustment will emphasise the lower, deeper frequencies and can be increased or decreased.

## Treble

Treble adjustment will emphasise the sharper, higher frequencies and can be increased or decreased.

## Balance

Balance affects the levels of sound between the left and right speakers. Adjustment can be made so that the level from the speakers will suit your listening position.



The headphone volume can be adjusted independently of the TV speakers so that everyone can enjoy listening at their own comfort level.

## 3D Subwoofer



3D Bass subwoofer can be switched to Off, Normal, or Full for super deep bass response.

## AI



The AI setting automatically analyses the incoming sound signal and processes it to give lower noise and optimum tone for the programme material.

## MPX



MPX will usually be set to Stereo to provide the best reproduction, however if reception deteriorates or if the service is not available then it is advisable to switch to Mono. Mono (M1) and (M2) can also be selected if signals are being transmitted.

## Ambience



Ambience provides a dynamic enhancer to simulate improved spatial effects.

# SETUP MENU

The Setup menu provides access to various advanced features and also to the Tuning menu

Open the Setup menu



Move to your choice



Increase or decrease levels, set options or access further menus



Press the TV/AV button to exit the Setup menu

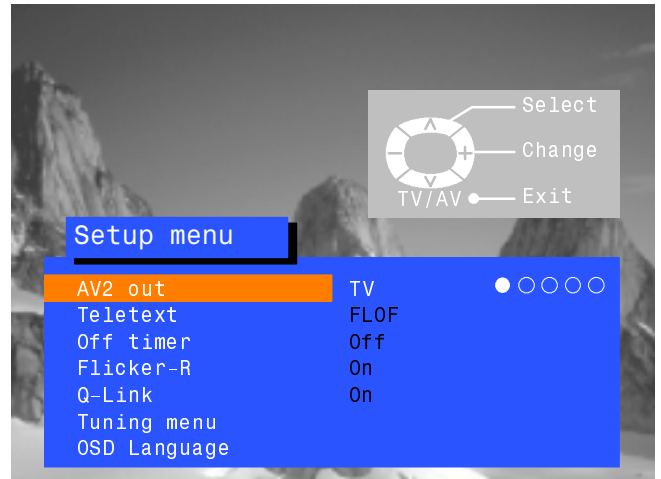

● ○ ○ ○ ○ ○  
**AV2 out**

AV2 offers you a choice of signals to send to the AV2 SCART socket. You can choose from the current TV programme position, the signal entering AV1/AV3/AV4 or Monitor – the picture displayed on screen.

● ○  
**Teletext**

The Teletext option allows you to choose between FLOF/TOP or LIST mode. See page 24.

● ○ ○ ○ ○ ○ ○ ○  
**Off timer**

Off timer will switch the TV off within a preset time which you can choose from between 0 to 90 minutes in 15 minute intervals.

● ○  
**Flicker-R**

You will normally find that Flicker-R is best set to On to reduce any slight picture movement. However, it is possible that some occasional broadcasts may benefit by selecting the Off position.

○ ●  
**Q-Link**

Q-Link allows you to enable or disable data communication when a VCR compatible with Q-Link, NEXTVIEWLINK or similar technology is connected. See page 22.

**Tuning menu**

The Tuning menu provides an entry to many other features including Programme edit and Auto setup. See page 13.

**OSD Language**

OSD Language allows you to select the language used for On Screen Displays. See page 20.

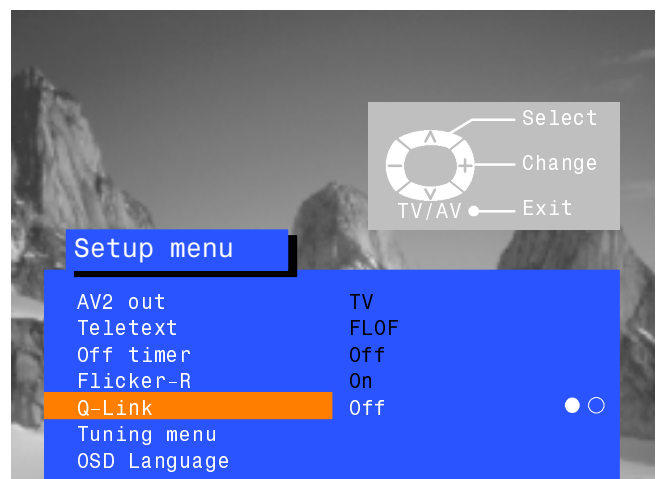
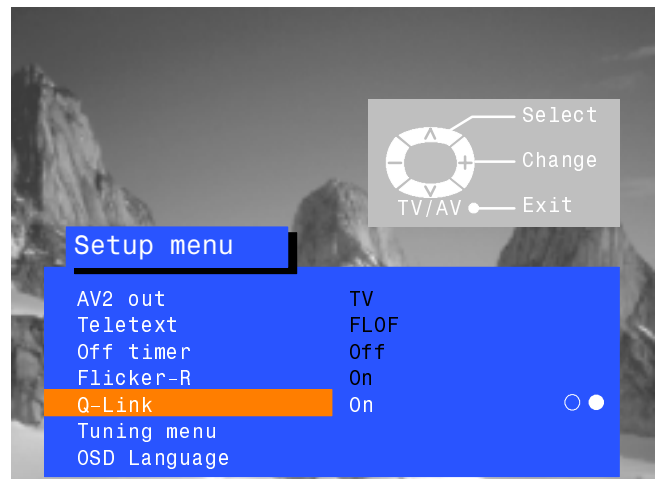

# TUNING MENU – overview

Open the Setup menu



Move to Tuning menu



Access Tuning menu



Move to your choice



Increase or decrease levels, set options or access further menus



Press the TV/AV button to exit

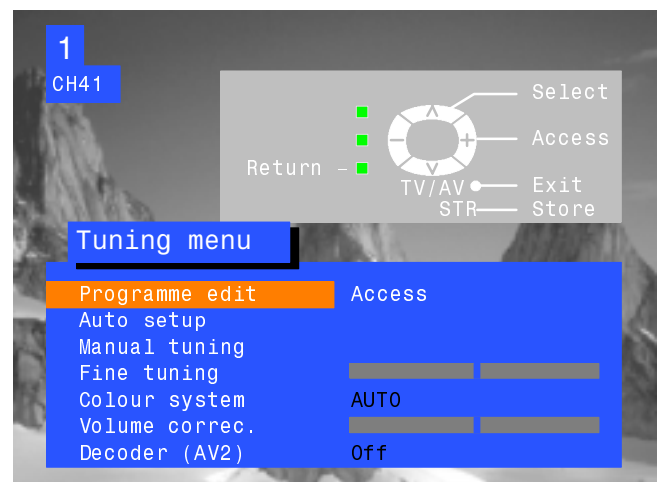
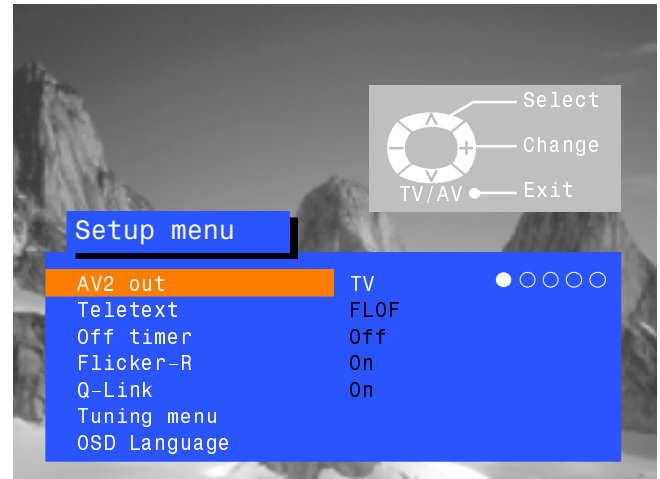

## Programme edit

Accessing the Programme edit menu will allow stations to be moved, added, deleted, named or locked. See page 14.

## Auto setup

The Auto setup menu allows you to automatically retune the TV. See page 18.

## Manual tuning

The Manual tuning menu allows individual programme positions to be tuned manually. See page 19.

## Fine tuning

Small adjustments to tuning can be made using the Fine tuning function.

## Colour system



The Colour system menu allows you to decide the correct choice of transmission standard.

## Volume correction

Volume correction allows you to adjust the volume level of individual stations.

## Decoder (AV2)



This option is used when a decoder is connected via AV2. Set to On if a scrambled signal is to be processed by the decoder. Set to Off after use.

# TUNING MENU – PROGRAMME EDIT

The Programme edit menu allows you to edit the programme position settings

Open the Setup menu



Move to Tuning menu



Access Tuning menu



Move to Programme edit menu



Access Programme edit menu



Make required changes  
(see sections below)

Press STR button to store changes



If you have finished in the Programme edit menu, press the TV/AV button to exit

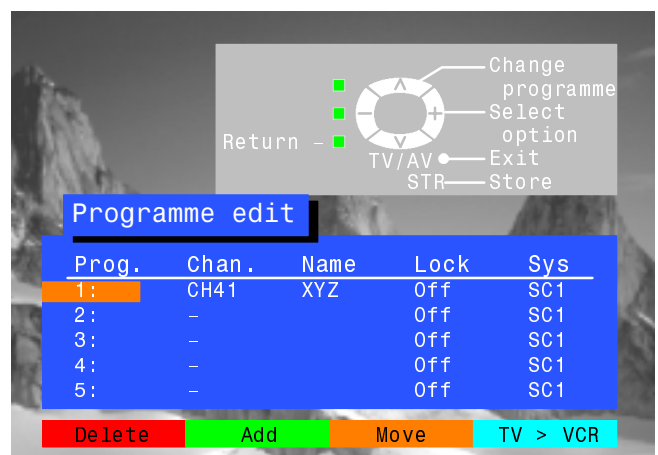
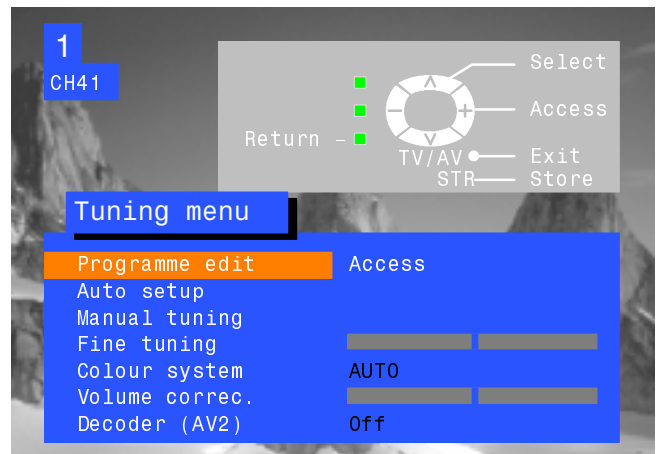
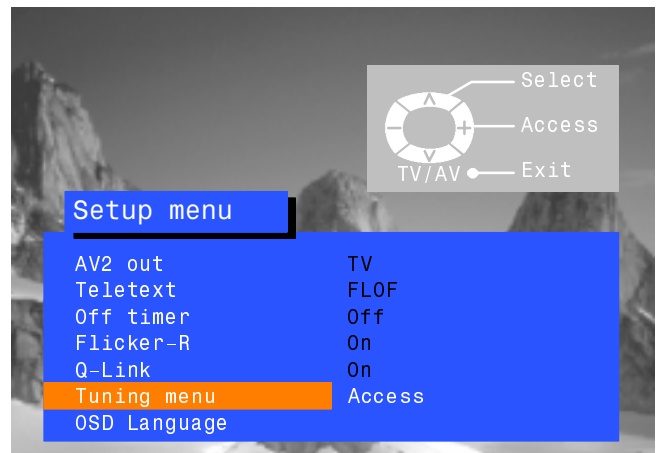
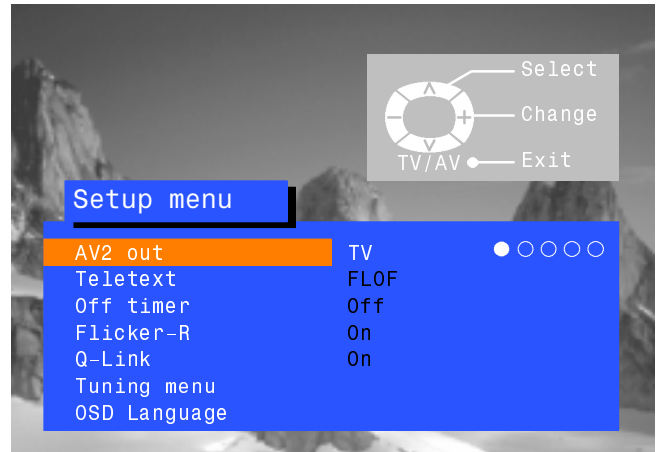

## To delete an unwanted programme position

Ensure that the cursor is in the Prog. Column

Choose the programme position



Press the Red button on remote control



Press the Red button again to confirm



If you have finished in the Programme edit menu, press the TV/AV button to exit



# TUNING MENU – PROGRAMME EDIT

## To add a programme position

Choose the programme position where the new programme is to be inserted



Press the Green button



Press the Green button again to confirm



This blank programme can then be tuned, named or locked.

Press STR to store



If you have finished in the Programme edit menu, press the TV/AV button to exit

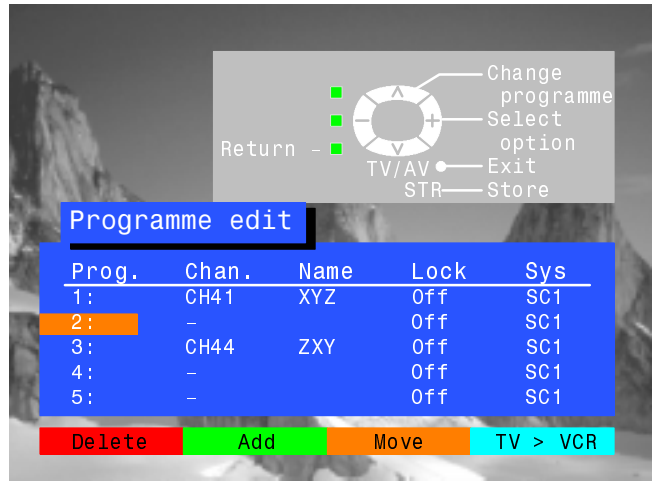

## To move a programme to another position

Choose the programme position to be moved



Press the Yellow button on remote control



Choose new position



Press the Yellow button again to confirm



If you have finished in the Programme edit menu, press the TV/AV button to exit

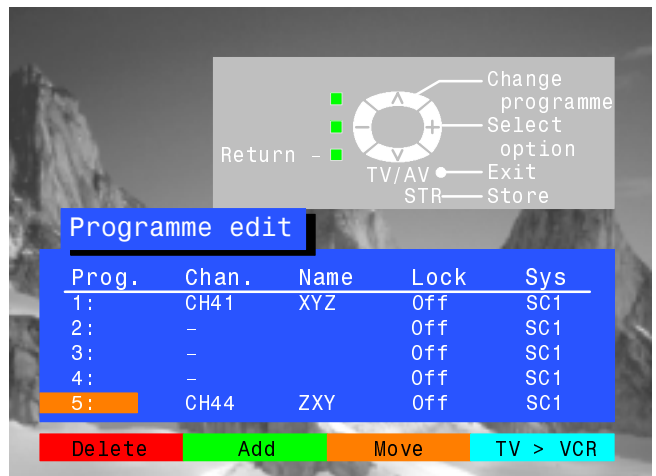
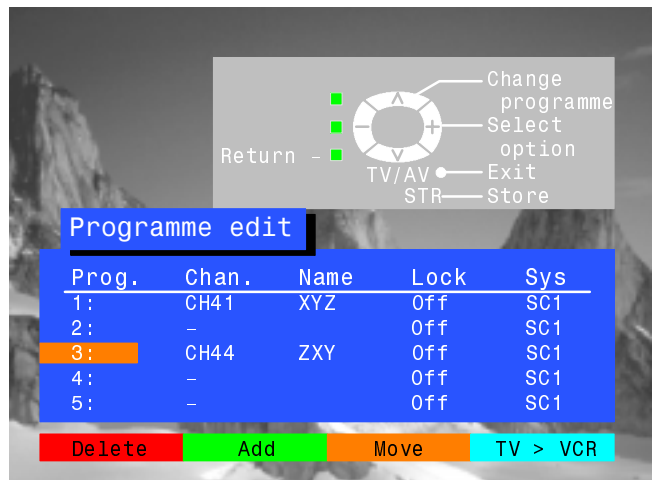



# TUNING MENU – PROGRAMME EDIT

## To tune a programme position

Choose the programme position



Move to the channel column



Increase or decrease channel number or use the 'C' key for Direct Channel Access (see page 5)



Press STR to store



If you have finished in the Programme edit menu, press the TV/AV button to exit

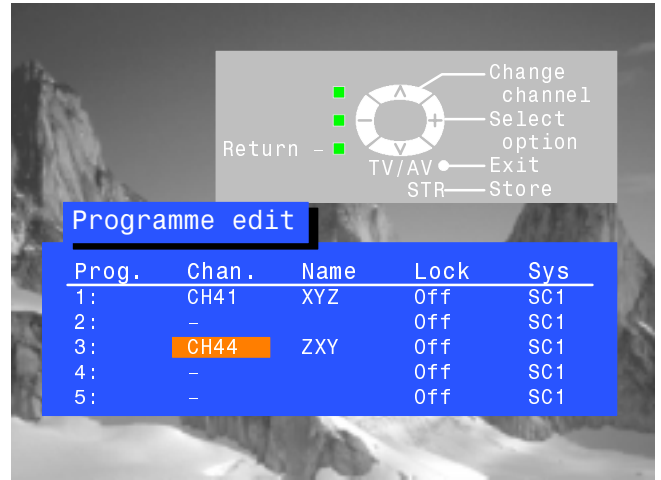

## To rename a programme position

Choose the programme position



Move to the Name column



Choose the new character



Move to the next character position



Continue until renaming is done

Press STR to store



If you have finished in the Programme edit menu, press the TV/AV button to exit

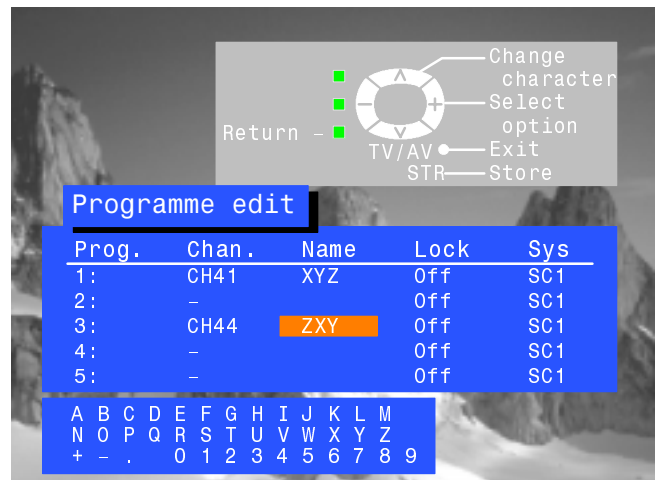

# TUNING MENU – PROGRAMME EDIT

## To lock a programme position to prevent access

Choose the programme position



Move to the lock column



Choose between lock On or lock Off



Press STR to store



If you have finished in the Programme edit menu, press the TV/AV button to exit



Note :

When a programme position is locked, Direct Channel Access using the 'C' and numeric keys on the remote control is not available.

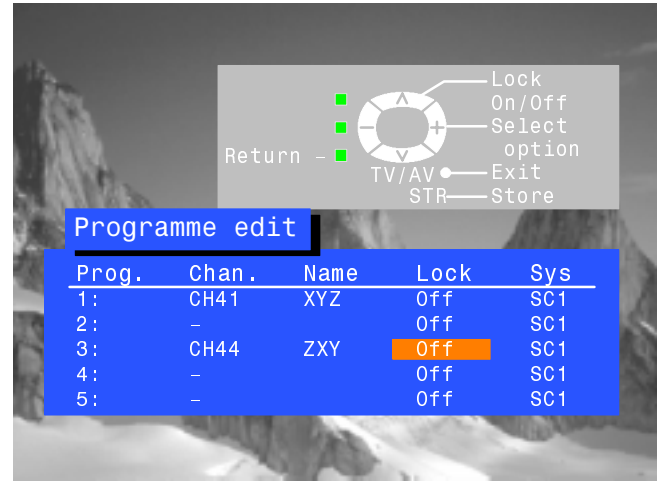

## To change the TV-system for a programme position

Choose the programme position



Move to the Sys column



Choose the required sound system:

SC1 : PAL B, G, H / SECAM B, G

SC2 : PAL I

SC3 : PAL D, K / SECAM D, K

F : SECAM L/L'



Press STR to store



If you have finished in the Programme edit menu, press the TV/AV button to exit

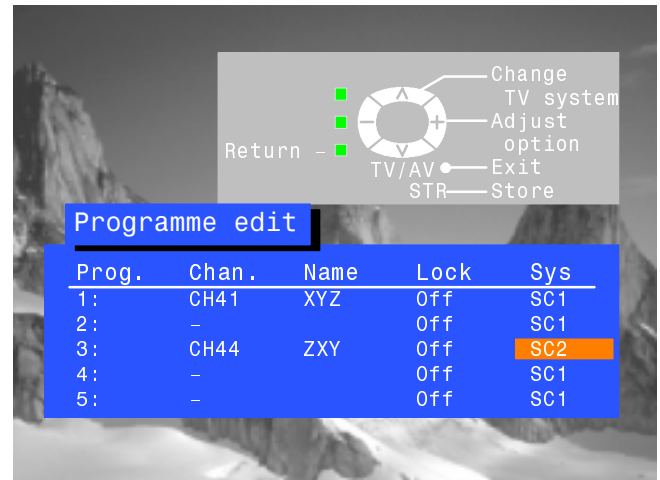

## To copy programme information to a compatible VCR connected to AV2

Move to the Prog. column



Press the Blue button on the remote control.

Programme data will now be sent to the VCR. This might take a few seconds, depending on the number of stations stored.





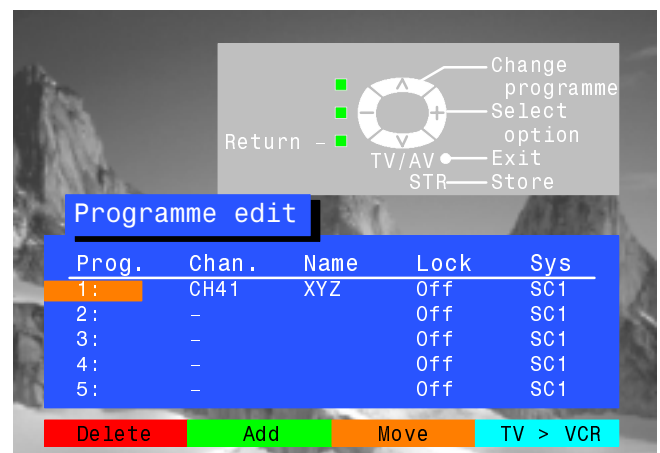





If you have finished in the Programme edit menu, press the TV/AV button to exit



# TUNING MENU – AUTO SETUP

The Auto setup menu will allow you to automatically retune the TV to your local stations.  
It is useful if you move to a different region

- Open the Setup menu 
- Move to Tuning menu 
- Access Tuning menu 
- Move to Auto setup 
- Access Auto setup 
- Press to confirm start 
- Select your country 
- Press to start Auto setup (ATP) 

The TV will search for, locate and sort into order your local stations. If a compatible VCR is connected via the AV2 socket, programme data will be sent to the VCR via Q-Link (see page 22).

Once this operation is completed the TV will display programme position 1.

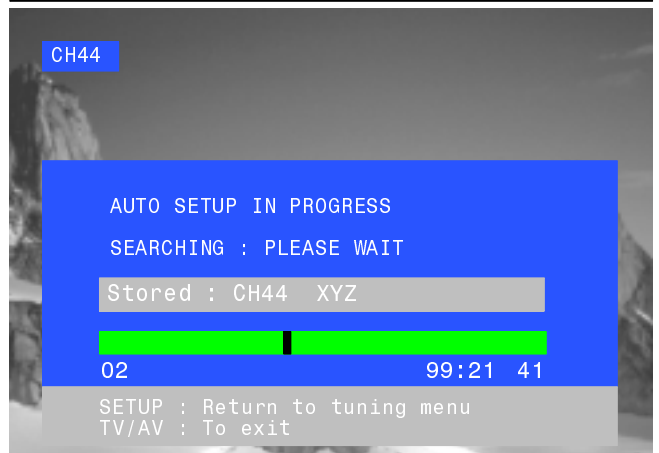
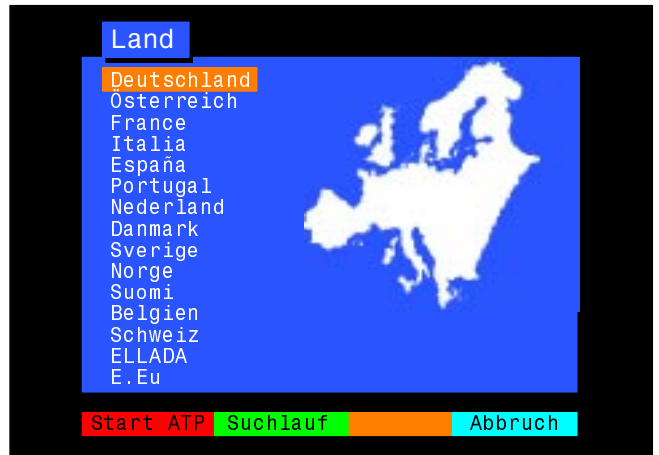
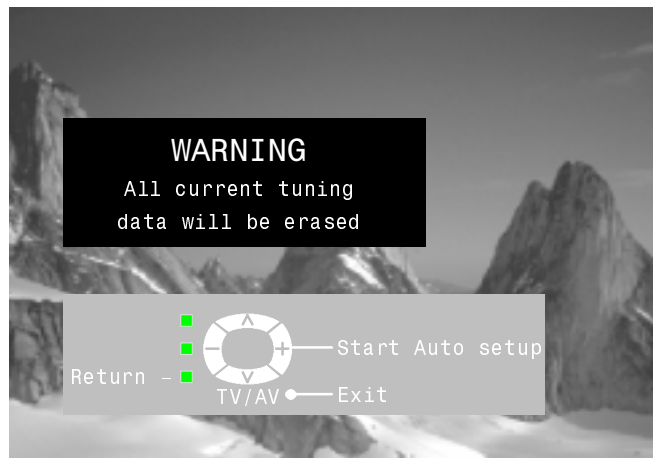
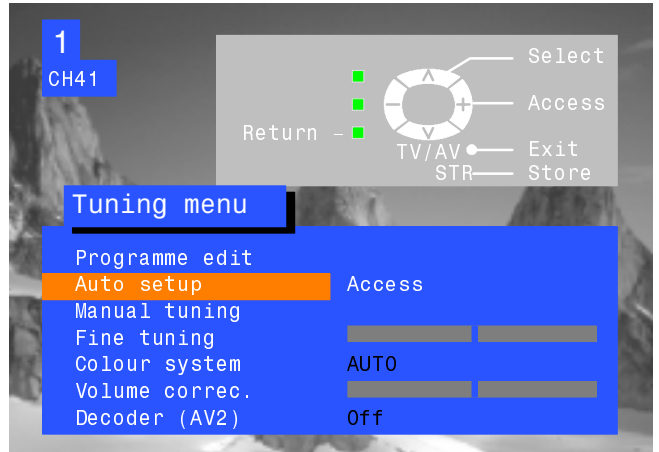

# TUNING MENU – MANUAL TUNING

Manual tuning of the programme positions is available either from the On Screen Display menu or from the front panel controls

## Manual tuning menu

Open the Setup menu

SET UP



Move to Tuning menu



Access Tuning menu



Move to Manual tuning



Access Manual tuning



Select the programme position to be tuned



Press repeatedly until required station is found



When the desired station is found, press STR to store.



The programme position will flash

Press the TV/AV button to exit.

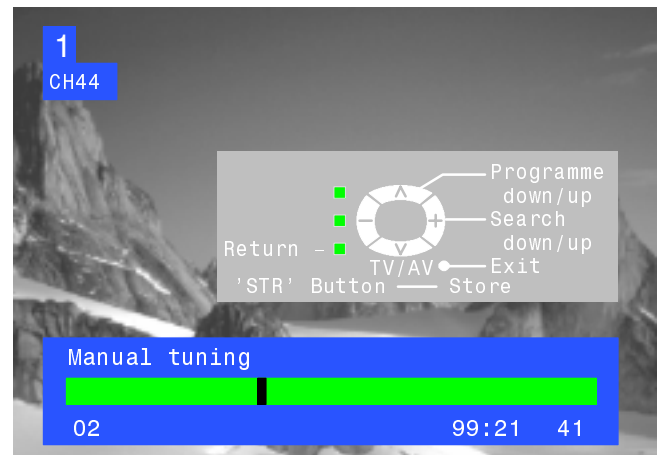
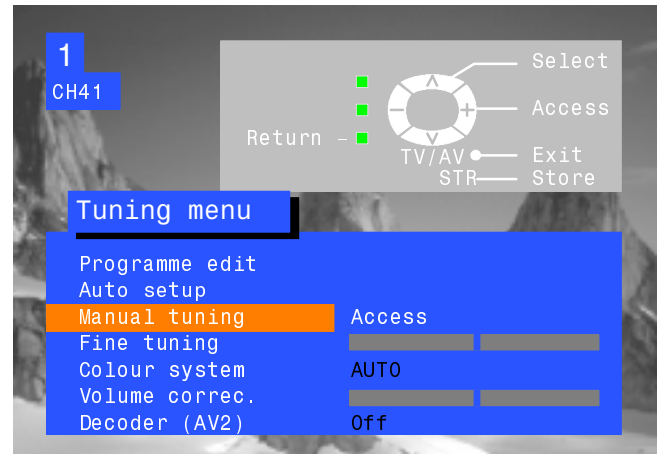

## Manual tuning (Front panel)

Press the F button (Front panel) until "Tuning mode" is reached



Press the - or + button to access Tuning mode

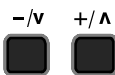

Press the TV/AV button to move between "Change programme", "Search" and "TV-System"



Press the - or + button to change programme position or start search

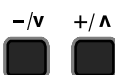

When the desired station is found, press STR to store.



The programme position will flash

Repeat above procedure to tune additional programmes or press the F button to exit

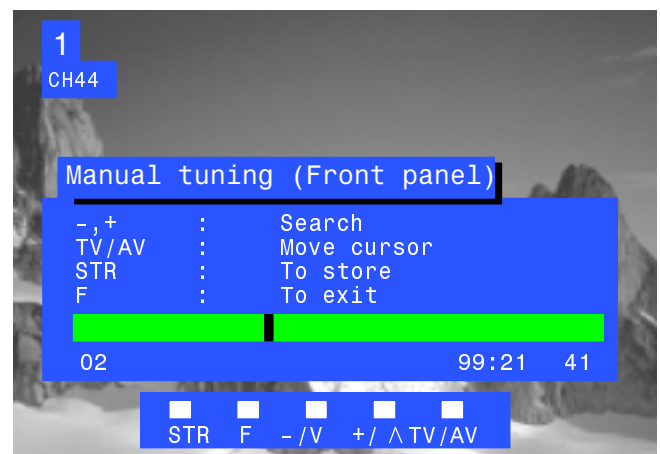

## OSD LANGUAGE

When you first installed the TV the On Screen Display language was set according to your choice of country. If you wish to use a different language then it can be chosen from the OSD language menu

Open the Setup menu



Move to the OSD language menu



Access the OSD language menu



Move to your choice



Press the TV/AV button to select and exit

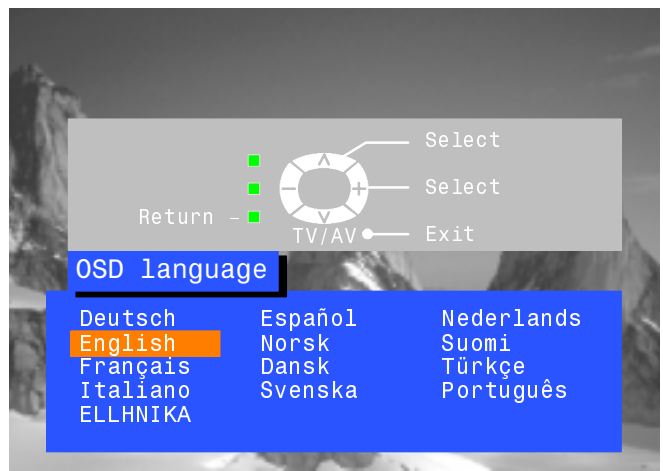
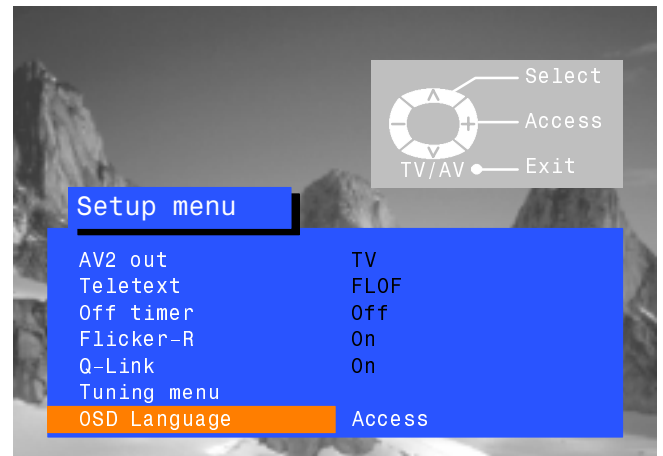

# AV SELECT AND SETUP

The AV Select menu will allow you to choose which AV source to view

Press the TV/AV button



Press the appropriate coloured remote control button (whilst the options remain on screen)



The options will disappear

You may wish to make adjustments in the Setup or Sound menus

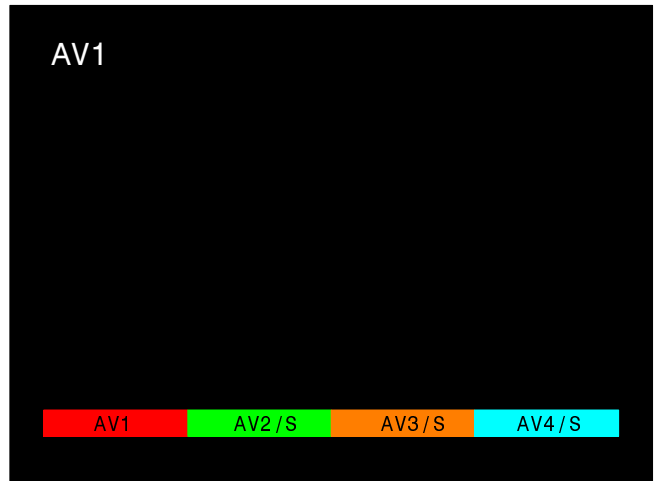

## Setup menu

Open the Setup menu



Move to your choice



Access adjustments or options



Press the TV/AV button to exit

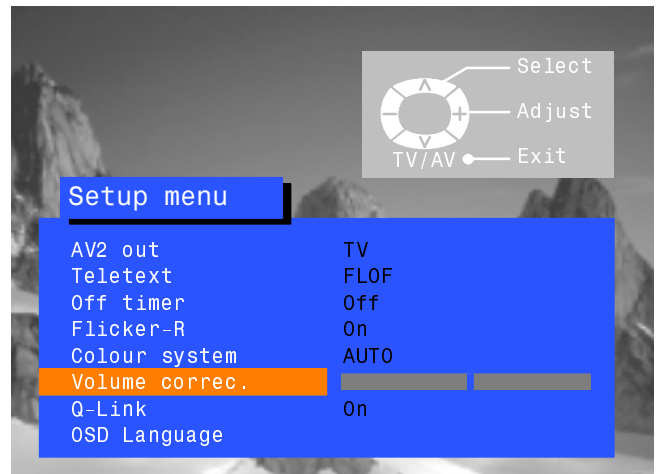

## Sound menu

Open the Sound menu



Move to your choice



Access adjustments or options



Press the TV/AV button to exit

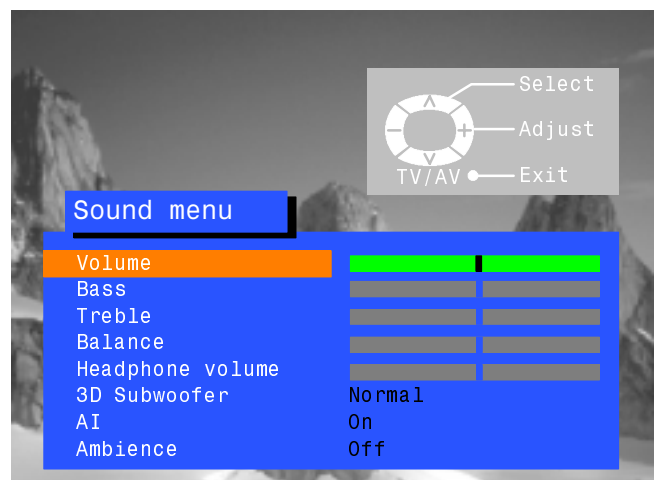

## Q-Link allows the television to communicate with your VCR

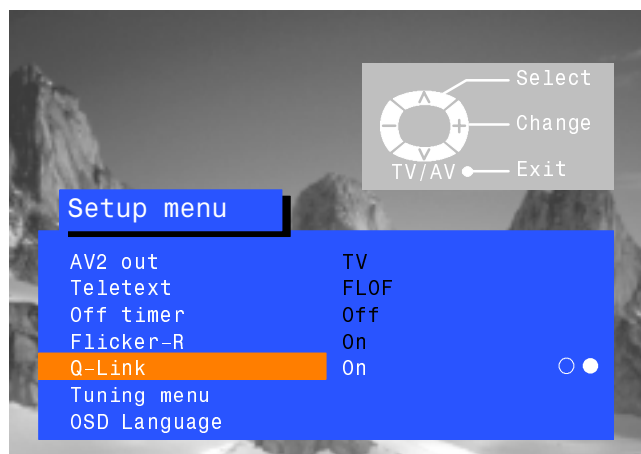
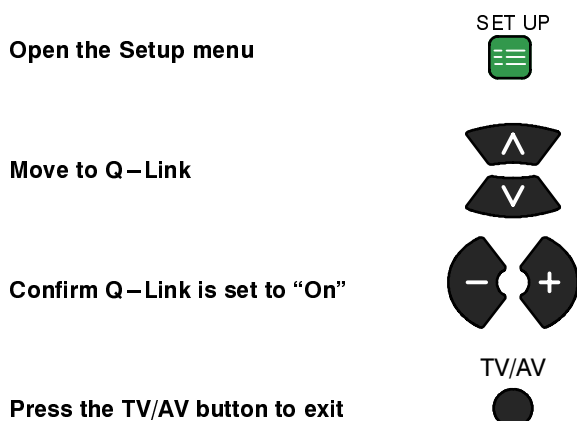

The VCR must be connected with a SCART lead (full function type) attached between the AV2 socket of the television and the appropriate socket on your VCR. See the VCR handbook for further information. Q-Link, NEXTVIEWLINK or similar technology allows the television to instruct a **compatible VCR** to record the programme that is currently being displayed on screen, regardless of the programme position set on the VCR, thus simplifying the process of recording programmes.

### To record the programme you are currently watching



Press the DIRECT TV REC button on the remote control

If the VCR is off, it will automatically switch on when you press the DIRECT TV REC button.

A message, sent from the VCR, will appear on screen showing what is being recorded, or if it is not possible to record:

VCR recording preset prog

VCR recording own tuner

VCR is recording the programme signal from its own tuner. If you wish you can switch off the TV and leave the VCR recording in the normal way.

VCR recording TV source

VCR is recording the programme signal from the television. You must not change programme position or switch off the TV: if you do, the VCR will automatically stop recording and switch off.

No recording TAPE IS PROTECTED

The write protection tab on the back of the cassette has been removed.

Examples of other messages that might be displayed are:

No recording NO TAPE

No recording VCR IS PLAYING

VCR Recording VCR external

No recording VCR ALREADY RECORDING

No recording TAPE MAY BE DAMAGED

No recording NO SOURCE AVAILABLE

### To share tuning information

To ensure correct recordings are made, the television and VCR should share tuning information – see page 17.

- Whenever the Auto setup (ATP) function is used, tuning data will be downloaded to the VCR.

### Auto Power functions

With Panasonic Q-Link VCRs these additional features are available:

- If you insert a tape in your VCR and press the Play button, the television will automatically switch on and select the AV2 input so you can view the tape.
- If you switch off the television whilst the VCR is in Stop, Fast Forward or Rewind modes, the VCR will switch off automatically.

### To turn off Q-Link communication

If you do not wish to use the Q-Link feature, go to the Setup menu and set the Q-Link option to "Off". See page 12.

#### Important Note:

Not all VCRs support this type of data communication system. Some may support certain features, but not others. See the VCR handbook for further information.

If Q-Link is inoperative, first confirm that your SCART lead is a full function type. Ask your dealer for further details.

## VCR / DVD OPERATION

The Remote Control is capable of operating some functions of selected Panasonic VCRs and DVD (Digital Versatile Disc) equipment. Some VCR and DVD equipment have different functions, so to ensure compatibility please refer to the equipment's instruction book or consult your dealer for details.



### Standby

Press to switch the VCR or DVD to standby mode. Press again to switch back on.



### VCR / DVD switch

Use this switch to select whether controls operate DVD equipment or your VCR.



### Play

Press to playback the tape or DVD.



### Stop

Press to stop the tape or DVD.



### Skip / Fast Forward / Cue

VCR: Press to fast forward the tape. In Play mode, press to view the picture rapidly forward (Cue).  
DVD: Press once to skip to the next track. In play mode press and hold to view the picture rapidly forward.



### Skip / Rewind / Review

VCR: Press to rewind the tape. In Play mode, press to view the picture rapidly in reverse (Review).  
DVD: Press once to skip to the previous track. In play mode press and hold to view the picture rapidly in reverse.



### Pause / Still

Press in playback mode, the picture will pause. Press again to restart play.



### Programme Up / Down

Press to increase or decrease the VCR programme position by one.



### Record

Press this button to start recording.



# TELETEXT OPERATION

- Teletext features may vary depending on the Broadcasting Companies and is only available if the channel selected is transmitting Teletext.
- Pressing the Picture button whilst in Teletext operation will display the brightness function with a white bar, press ◀ ▶ to alter the setting as required.  
Pressing the Setup button whilst in Teletext operation will display special function options at the bottom of the screen.
- When in Teletext mode, the volume may still be altered to the desired listening level.

## What is LIST mode ?

In LIST mode, four differently coloured page numbers are situated at the bottom of the screen. Each of these numbers can be altered and stored in the TV's memory.

## What is FLOF?

In FLOF mode, four differently coloured subjects are situated at the bottom of the display. To access more information about one of these subjects, press the appropriately coloured button. This facility enables fast access to information on the subjects shown.

TV/TEXT



### TV / Teletext mode

Press the **TV/TEXT** button.  
The screen will display the Teletext page.  
Press again when you wish to return to TV. mode.



### Page Selection

Pages can be selected in two ways :

- Press the Up / Down buttons to increase or decrease the page number by one.
- By entering the page number, using 0 –9 on the remote control.

SET UP



### Full / Top / Bottom

Press the **SET UP** button to display special functions, followed by the **Green** button.  
Press the **Green** button again to expand the **BOTTOM** half.  
Press again to return to normal (**FULL**) size.

SET UP



### Reveal

Press the **SET UP** button to display special functions, followed by the **Red** button to reveal hidden words e.g. quiz page answers. Press again to hide.



### Red / Green / Yellow / Blue buttons

In FLOF mode these correspond to the differently coloured subjects.  
In LIST mode they correspond to the differently coloured page numbers.

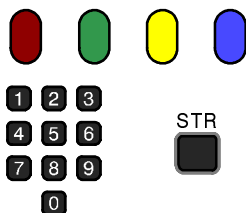

### List Store

In LIST mode the four page numbers can be altered (programme positions 1 – 25 only).  
To do this, press one of the four coloured buttons and enter the new page number.  
Press and hold **STR**, the page numbers will change to white indicating that the page is stored.

HOLD



### Hold

To hold the Teletext page when viewing multi–page information.  
Press again to return to automatic page update.

# TELETEXT OPERATION

It is not possible to change the programme position when in News flash, Update or Sub Coded Page Access operation.

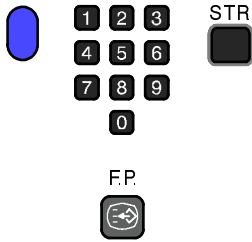

## Favourite Page (F.P.)

Stores a favourite page in memory for instant recall. To store such a page, the TV must be in LIST mode, and the programme position must be from 1 – 25.

Press the **Blue** button, select the page number, then press and hold the **STR** button. The page number is now stored.

Press **F.P.** to recall this page.

## Update Display

Press the **SET UP** button to display special functions, followed by the **Yellow** button to view the TV picture whilst searching for a Teletext page.

When found, the screen will display the page number at the top left.

Press the **Yellow** button to view the page.

Press **TV / TEXT** again to return to normal TV operation.



## News Flash

When a news flash page has been selected, press **SET UP, Yellow**, to view the TV picture. When an update is received, the page number will be displayed on screen.

Press the **Yellow** button to display the News Flash

Press **TV / TEXT** to return to normal TV. operation.

## Update

Press **SET UP, Yellow** to see the update of information on certain pages.

When an update is received, the page number will be displayed at the top left of the screen.

Press the **Yellow** button to view the page.

Press **TV / TEXT** to return to normal TV. operation.



## Sub Coded Page Access

When Teletext information exceeds more than one page, it may take some time for the automatic changing of the sub pages to reach the sub page you require.

It is possible to enter your required sub page and continue watching the normal programme until the correct sub page is found.

Select the required page number using buttons 0 – 9.

Press the **SET UP** button followed by the **Blue** button; T\*\*\*\* will be displayed at the top right of the screen.

Enter desired sub page number before the T\*\*\*\* disappears.  
To select page 6 enter 0, 0, 0 and 6.

(If in LIST mode, a 'T' will appear in the current box at the bottom).

Press the **Yellow** button to view a normal TV programme.  
(Press **SET UP, Yellow** in LIST mode).

When the page is available, press the **Yellow** button to view the page.  
To clear the page perform one of the following :

- Press **SET UP**.
- Select a new page number.
- Press **TV/TEXT** to return to normal TV operation.



## Index

### When in FLOF operation

Press **INDEX** to return to the main index page.

Depending on the way information is transmitted, this may have to be pressed more than once to return to the main index page.

# AUDIO / VIDEO CONNECTIONS

## Front AV3 4 pin S-Video, RCA Audio / Video and Headphone Sockets

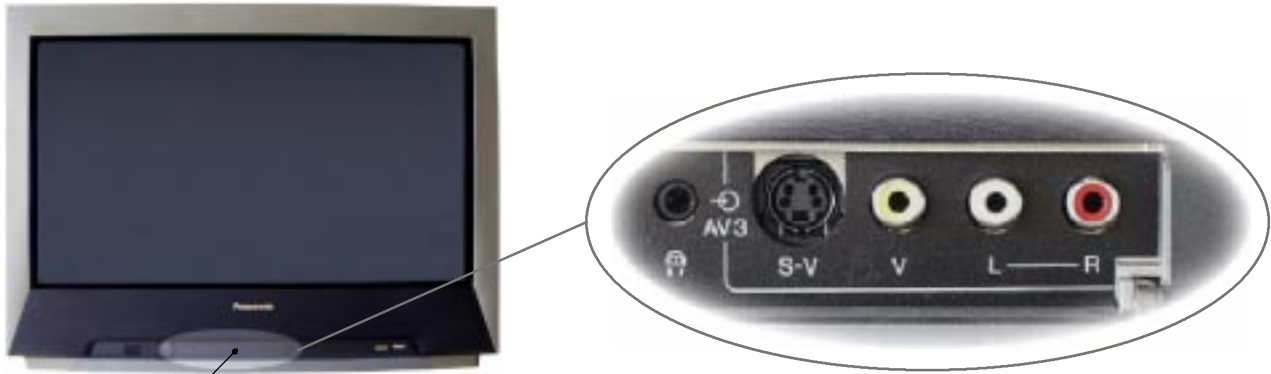

Press and release to open

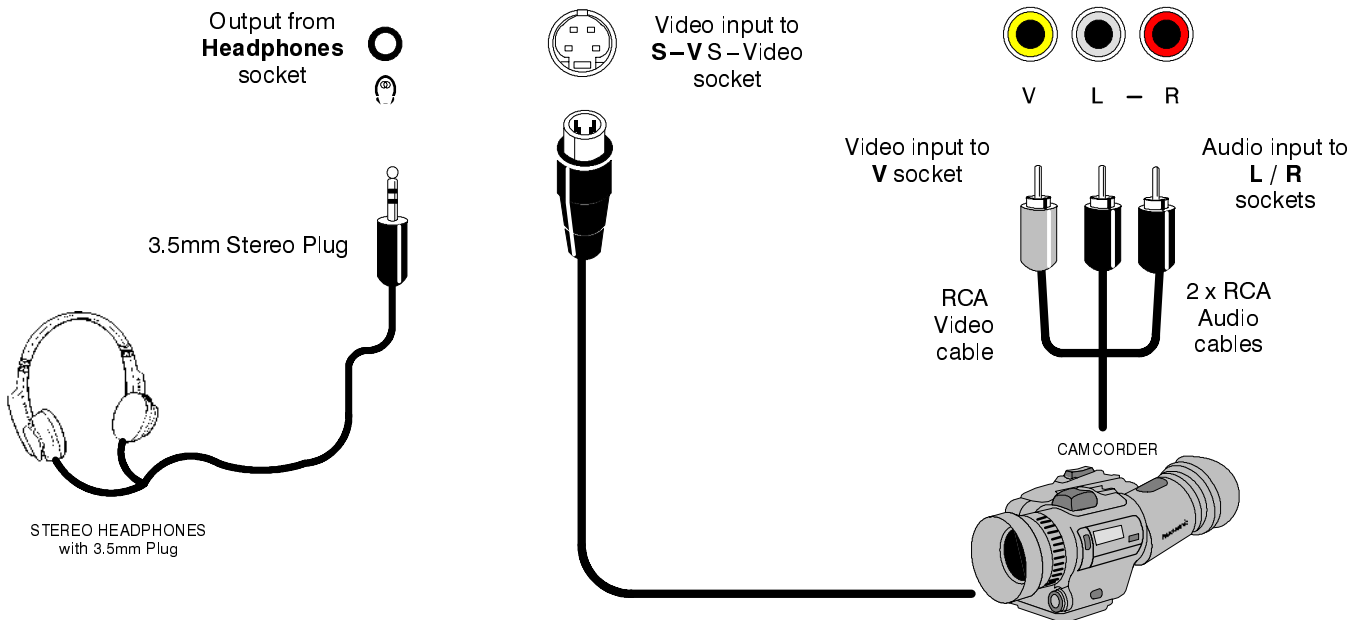

**Note :**  
Additional equipment and cables shown are not supplied with this TV set.

### ■ Scart and S-video socket information

#### AV1 and AV4 Scart sockets

Socket Earth	21		20	CVBS in (video)
CVBS out (video)	19		18	RGB status earth
CVBS earth	17		16	Status RGB
Red in	15		14	Earth
Red earth	13		12	--
Green in	11		10	--
Green earth	9		8	Status CVBS
Blue in	7		6	Audio in (L)
Blue earth	5		4	Audio earth
Audio out (L)	3		2	Audio in (R)
Audio out (R)	1			

#### AV2 Scart socket (S-Video, Q-Link)

Socket Earth	21		20	CVBS in (video)
CVBS out (video)	19		18	Earth
CVBS earth	17		16	--
S.C. - In	15		14	Earth
Earth	13		12	--
--	11		10	Q-Link data
Earth	9		8	Status CVBS
--	7		6	Audio in (L)
Earth	5		4	Audio earth
Audio out (L)	3		2	Audio in (R)
Audio out (R)	1			

#### S-Video 4 pin socket

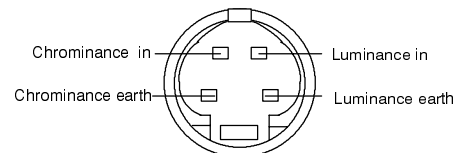

Suitable inputs for **AV1** include RGB (Red/Green/Blue). **AV4** does not have RGB input capability.

**AV2** - Pins 15 and 20 are dependent on AV2 S-VHS / VIDEO switching.

# AUDIO / VIDEO CONNECTIONS

## Rear AV1/AV2(S)/AV4(S) 21 Pin Scart and RCA Audio Out Terminals

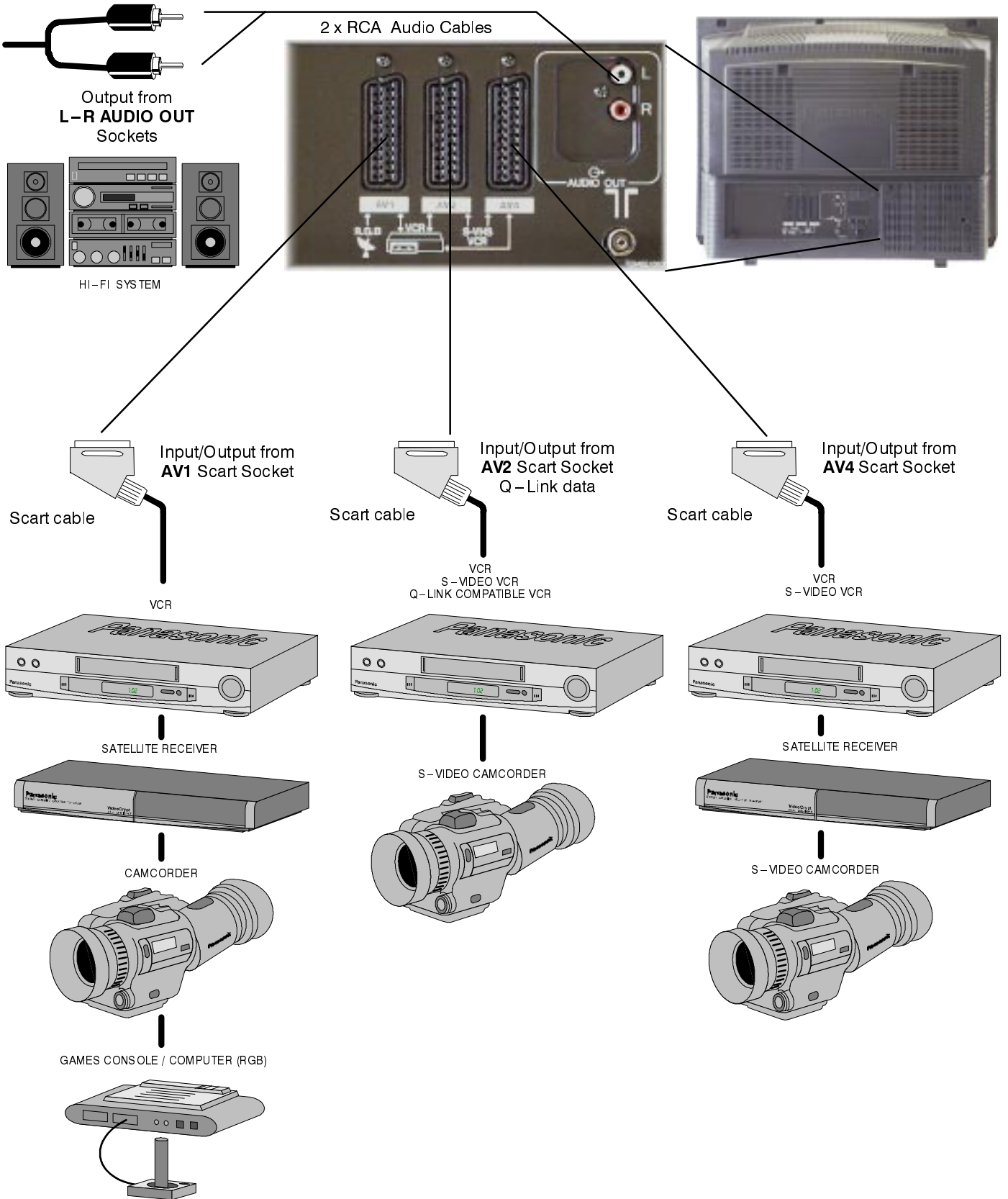









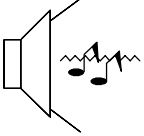
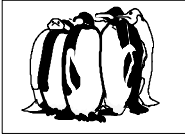
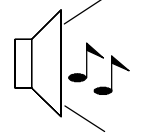
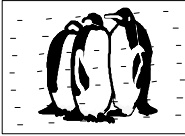
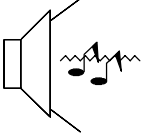
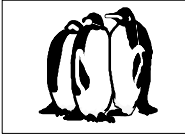
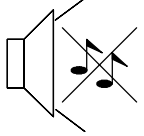

**Notes:**

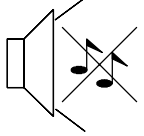
Additional equipment and cables shown are not supplied with this TV set.

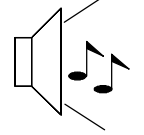
Do not connect a computer with TTL output (5V) to this set.

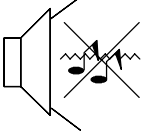
The AV2 21 pin terminal can also be used as an output to Audio/Video equipment; see page 12 for details.

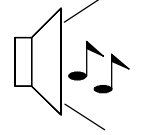
# TROUBLE-SHOOTING

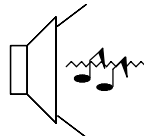
Symptoms		Checks
Picture	Sound	
 Snowy Picture	 Noisy Sound	Aerial location, direction or connection
 Multiple Images	 Normal Sound	Aerial location, direction or connection
 Interference	 Noisy Sound	Electrical appliances Cars / Motorcycles Fluorescent lights
 Normal Picture	 No Sound	Volume level Sound mute switched on
 No Picture	 No Sound	TV set to AV mode Not plugged into A.C. outlet Not switched on Picture / Sound controls set at minimum levels Check if in standby mode
 No Colour	 Normal Sound	Colour controls set at minimum levels
 Poor or Distorted Picture	 Weak or No Sound	Retune Channel(s)
 Coloured Patches	 Normal Sound	Magnetic Interference from unshielded equipment Receiver moved while switched ON, switch TV off for 30 minutes.
 Normal Picture	 Weak or distorted sound	Sound reception may have deteriorated. Switch MPX setting (Sound menu) to Off until reception improves.

## FOR YOUR GUIDANCE

### ■ Service

Before requesting service, please refer to the trouble-shooting guide on previous page to determine the symptoms. To obtain service please contact your local Panasonic dealer quoting the model number and serial number (both are located at the rear of the TV).

### ■ TV Games / Home Computers

Extended use of TV games or home computers with any television set can cause a permanent 'shadow' on the screen. This type of irreversible picture tube damage, can be limited by observing the following points:

- Reduce the brightness and contrast levels to a minimum viewing level.
- Do not operate the television set for a continuous period of time while using TV games or home computers.
- This type of picture tube damage, is not an operating defect, and as such is not covered by the Panasonic warranty.

### ■ Sleep Feature

If the set is not switched off when the TV station stops transmitting, it will automatically go to standby mode after 30 minutes. This function will not operate when the TV is in AV mode.

### ■ Last Position Memory

Certain functions have a last position memory, i.e. the setting at the time of switch-off will be the setting used when the receiver is switched on again: -

Programme	Tint
Headphone volume	(M.NTSC / NTSC only)
AV Position	Contrast
Volume	Sharpness
MPX	Aspect
Bass	Standby
Treble	Artificial Intelligence (AI) (Picture & Sound)
Balance	Flicker-R
Colour Balance	Colour
Status	Brightness
Teletext mode	P-NR
Decoder (AV2)	Q-Link
Surround mode	Volume correction (in AV mode only)
Speaker distance	Speaker level setting

## SPECIFICATIONS

		TX-W32D5F	TX-W28D5F
<b>Power Source</b>		220 - 240V 50Hz A.C.	
<b>Power Consumption</b>		169W	159W
<b>Standby Consumption</b>		1,9W	
<b>Picture Tube</b> Visible Diagonal		76 cm	66 cm
<b>Audio Output</b> Music Power		Front Left / Right 20W x 2, Subwoofer 26W	
<b>Dimensions</b>	H	577,6 mm	523,2 mm
	W	778,0 mm	684,0 mm
	D	535,0 mm	510,0 mm
<b>Weight (Kg)</b>		53,5	38,5
<b>Receiving Systems/ Band name</b>		<b>PAL B, G, H, I, SECAM B,G SECAM L/L'</b> VHF E2 - E12 VHF A - H (ITALY) UHF E21 - E69 CATV (S01 - S05) CATV S11 - S20 (U1 - U10) <b>PAL D,K, SECAM D, K</b> VHF R1 - R2 VHF R6 - R12 <b>PAL 525/60</b> Playback of NTSC tape from some PAL video recorders (VCR) <b>M.NTSC</b> Playback from NTSC 4,43 MHz Videorecorders (VCR) <b>NTSC (AV input only)</b> Playback from NTSC Videorecorders (VCR)	
<b>Aerial - Rear</b>		UHF / VHF	
<b>Headphones - Front</b>		3,5mm, 8Ω impedance	
<b>AV - Rear</b>		<b>AV1</b> - 21 pin terminal - Audio / Video in / out, RGB in. <b>AV2</b> - 21 pin terminal - Audio / Video in/out, S-Video in, Q-Link <b>AV4</b> - 21 pin terminal - Audio / Video in / out, S-Video in 2 x RCA Audio Monitor Out.	
<b>AV - Front</b>		<b>AV3</b> - S-Video in, 1 x RCA Video in, 2 x RCA Audio in	

Specifications are subject to change without notice. Weight and dimensions shown are approximate.